

# INDUSTREX Films

2014-10-22 • TI-6K7080

## Film Types and Features

Film	Features and Customer Product Specifications	Classification	
		INDUSTREX M43ic Processor, INDUSTREX Single Part Developer Replenisher, 8 minutes at 79 °F (26 °C)	
		ASTM E1815	EN ISO 11699-1
<b>DR50</b>	<ul style="list-style-type: none"> <li>• Ultra-fine grain</li> <li>• High contrast and excellent sensitivity</li> <li>• For critical radiography, especially with high voltage x-rays and gamma rays</li> <li>• Excellent for use in multi-films techniques</li> </ul>	Special	C1
<b>M100</b>	<ul style="list-style-type: none"> <li>• Ultra-fine grain</li> <li>• Medium speed, very high contrast, high definition (excellent sensitivity)</li> <li>• For critical radiography, such as weld inspection related to the nuclear industry</li> </ul>	Class I	C2
<b>MX125</b>	<ul style="list-style-type: none"> <li>• Very fine grain</li> <li>• Medium speed, very high contrast, high definition</li> <li>• For a wide range of critical radiography such as aeroengine, weld, fabrication, investment castings and assemblies</li> </ul>	Class I	C3
<b>T200</b>	<ul style="list-style-type: none"> <li>• Very fine grain</li> <li>• Medium speed, high contrast</li> <li>• For a wide range of critical radiography such as weld fabrication, investment castings and assemblies</li> <li>• For use in multiple film radiography and in single film</li> </ul>	Class I	C4
<b>AA400</b>	<ul style="list-style-type: none"> <li>• Fine grain</li> <li>• High speed, high contrast</li> <li>• Suitable for weld and casting inspection</li> <li>• Often used in multiple film techniques</li> </ul>	Class II	C5
<b>HS800</b>	<ul style="list-style-type: none"> <li>• Medium grain</li> <li>• High speed, high contrast with direct x-rays, with lead screens, with fluorescent or with fluorometallic screens</li> <li>• Suitable for low and high voltage equipment, and gamma sources</li> <li>• For concrete and heavy construction, offshore pipeline, and thick wall casting applications</li> </ul>	Class III	C6

**Note:** All INDUSTREX Films can be used with direct x-rays or with lead screens. High Speed HS800 can be used with direct x-rays, with lead screens, with fluorescent, or with fluorometallic screens.

Thickness for all INDUSTREX Films		
Base / Support	0.18 mm	7.08 mil
Emulsion	25.00 µm	1.00 mil
Overcoat	10.00 µm	0.40 mil
Total	0.21 mm	8.40 mil

## Available Packaging Formats

Packaging formats are identified by a suffix after the film type ID. Use the following key to identify the package format, and find detailed descriptions of each format below.

Package Format and Suffix			
Sheet Film		Roll Film	
Interleaved	5	Ready Pack	381
Non-Interleaved	1	Lead Pack	382
PbContactPak	7	NIF bulk roll	359
Ready Pack II Film	2		

**Note:** All packaging formats are available for all INDUSTREX Films, excluding the HS800. HS800 NIF Bulk Rolls are available in EAMER. The HS800 Pb ContactPak is available in APR.

### PACKAGING FORMAT DESCRIPTIONS

#### Sheet Film—Interleaved (INT) (suffix 5)

Each film is supplied individually enclosed in a white folder for extra protection during handling procedures. For most sizes, the unit pack is 100 sheets provided as 2 x 50 sheets. The film can be loaded into metal or plastic cassettes or into exposure holders, with or without lead screens.

#### Sheet Film—Non-Interleaved (NIF) (suffix 1)

This form of packaging is generally supplied in packs of 100 sheets, and is for use when film is to be loaded into metal or plastic cassettes, or exposure holders, with or without lead screens.

#### Sheet Film—Pb Contactpak (suffix 7)

This pack consists of a film sandwiched between two 27-micron thick lead screens sealed in a lighttight, water-resistant, flexible package. A vacuum inside the pack provides superb film/screen contact. The package is laser-scored for easy opening. The film type is identified on the package as well as embossed on the film itself. The package has a butt edge which is invaluable for accurate positioning in difficult situations where the image needs to fall right up to the edge of the pack. Product in this packaging is clean to use, is water and oil resistant and is available for exposure immediately.

#### Sheet Film—READY PACK II (suffix 2)

These films are individually vacuum sealed in lighttight, water-resistant, flexible packages. The package is laser-scored for easy opening. The film type is identified on the package as well as embossed on the film itself. The package has a butt edge which is invaluable for accurate positioning in difficult situations where the image needs to fall right up to the edge of the pack.

#### Roll Film—READY PACK (suffix 381)

The film is supplied in a long, lighttight roll sandwiched between two yellow-black paper polyethylene layers. The rolls are of 60- or 100-metre lengths in a variety of widths. The film is provided in a dispenser box and is cut to length by the user in a darkroom.

#### Roll Film—LEAD PACK (suffix 382)

The film is supplied sandwiched between two 27-micron thick lead screens inside a long, lighttight paper and polyethylene sleeve. The rolls are 100 metres long and are cut to length by the user in a darkroom.

#### Roll Film—NIF Bulk Roll (suffix 359)

The film is supplied on a cardboard core in rolls 150 metres long in three widths: 60 mm, 70 mm and 100 mm. The 70 mm is also available in the 305 metre lengths. The film must be loaded into a cassette in a darkroom.

### SAFELIGHT RECOMMENDATIONS

Use a red safelight filter in a suitable safelight lamp equipped with a 15-watt bulb. Keep the film at least 4 feet (1.2 metres) from the safelight.

**Note:** Other safelight filters that block radiation at 550 nm and shorter wavelengths are also suitable for use.

## STORAGE AND HANDLING

Always handle the film with care to avoid physical strains such as pressure, creasing, or buckling damage.

Very high-speed x-ray films, such as HS800 Film, are photosensitive to physical handling marks that occur prior to processing. Pressure to the film's surface can cause minus density marks to develop, such as might result from kinking the film or pressure from debris inside cassettes or screens. To avoid these types of handling artifacts, carry a single sheet of film, handling it carefully by the two opposite corners. Alternatively, gently bend the film in half and grasp it with your thumb and middle finger and place your index finger in between to keep the film surfaces separated. Keeping the long dimension parallel to the floor is easier.

It is important to realize that meeting the chemical and physical requirements do not ensure that records will not deteriorate. It is essential to provide proper storage conditions. ASTM E1254 gives details of storage conditions. ISO 18911 and ISO 18902 give—for processed films—recommended storage conditions and specifications for the respective enclosure materials.

### Unexposed

50 to 75.2 °F (10 to 24.0 °C), 30 to 50 % RH. Properly shield from x-rays, gamma rays, or other penetrating radiation.

### Exposed

Keep cool, dry, and properly shielded from penetrating radiation. Process as soon as possible after exposure.

### Processed

60 to 80 °F (15 to 27 °C), 30 to 50 % RH.

## RELATIVE EXPOSURE

EXPOSURE CONDITIONS: 8 mm Copper Filtration, HVL 3.5 mm Copper (220 kV), Lead screens

INDUSTREX Films	INDUSTREX Processor INDUSTREX Chemicals
	8 min 79°F (26°C)
DR50	7.2
M100	4.2
MX125	2.8
T200	1.7
AA400*	1.0
HS800	0.5

\* AA400 Film in 8 min 79°F (26°C) cycle is assigned a relative exposure of 1.

## RELATIVE EXPOSURE FOR VARIOUS ENERGY LEVELS

In the Relative Exposure Factors table below, notice that for each exposure condition, the AA400 Film—in 8 minutes, 26 °C (79 °F)—is assigned a relative exposure of 1.00.

INDUSTREX Films	Relative Exposure for Various Energy Levels			
	ISO 120kV*	EN 220kV†	Iridium‡	Cobalt§
DR50	9.0	7.2	9.0	9.0
M100	4.1	4.2	5.4	6.3
MX125	2.9	2.8	3.1	3.3
T200	1.6	1.7	1.9	1.9
AA400	1.0	1.0	1.0	1.0
HS800	—	0.5	—	—

\* In accordance with ISO 7004 standard, without lead screens

† In accordance with ISO 7004 standard - EN ISO 11699-1 Lead screens

‡ 8 mm Copper filtration. 100/200 microns lead screens

§ 100/200 microns lead screens

# Automatic Processing

## RECOMMENDED CHEMICALS

### INDUSTREX Single Part Developer Replenisher

INDUSTREX Single Part Developer Replenisher is a universal, single-part concentrate used to process all types of non-destructive testing film. As its name implies, this is a single part liquid concentrate for easy mixing. It is compatible with existing automatic processing cycles of 8 minutes and longer, and allows a shorter processing cycle (5 minutes) for all films.

The developer formula allows high photographic consistency and quality, and ensures an efficient use of the developer when using a low replenishment rate and it also reduces any environmental impact. This developer reduces or minimizes operator maintenance due to crystallization, silver deposits, or sludge.

#### Features:

- High chemical stability—includes consistent image quality over an extended period of time, improved resistance to aerial oxidation, and low sludge formation
- Designed for use in both automatic and manual processing
- Reduced packaging, less solid waste
- Glutaraldehyde free
- Strengthened “activation power” which allows for fast processing and high productivity
- Outstanding image quality—cold (blue) image “tone” and low granularity
- Reduced environmental impact—lower COD and BOD<sub>5</sub> (5-days Biochemical Oxygen Demand)
- Concentrated (single part) liquid developer provides ease of use
- Can be used in chemical auto-mixers

### INDUSTREX LO Fixer and Replenisher

This fixer is recommended to process all types of industrial imaging film in automatic and manual processing cycles.

This fixer consists of a single part liquid—just add water to the proper dilution. For use, the concentrate must be diluted with water according to the instructions provided below (see “Mixing Instructions.”)

#### Features:

- Low odor
- Improved archivability
- Reduced environmental impact—lower COD and BOD<sub>5</sub> (5-days Biochemical Oxygen Demand)
- Concentrated (single part) liquid fixer provides ease of use
- Designed for use in both automatic and manual processing
- Can be used in chemical auto-mixers

### Compatibility

INDUSTREX Single Part Developer Replenisher and INDUSTREX LO Fixer and Replenisher can be used with all INDUSTREX Films.

### Storing Solutions

To maintain product quality, these chemicals must be stored in the original package, at a temperature between 5 and 30°C (41 to 86°F). When stored in these conditions, the lifetime is two years from the date of manufacture.

Discard solutions if there is evidence of contamination, dirt, over-dilution, excessive evaporation, or crystallization.

### Mixing Instructions

**Notice:** Observe precautionary information on product labels and on the Material Safety Data Sheets.

### INDUSTREX Single Part Developer Replenisher

INDUSTREX Single Part Developer Replenisher is supplied in a quantity to prepare 38 litres (2 x 19 litres) or 40 litres (2 x 20 litres) of working solution, depending on geographic region, and consists of plastic containers of concentrated developer solution.

## Mixing Developer Replenisher

To Make Working Strength Solution	Start with Water at 10 - 30°C (50 - 86°F)	Add Concentrate (Number of Bottles)	Fill to:	Stir
19 L	10 L	1	19 L	Stir for about 2 minutes until a completely homogeneous solution is obtained.
20 L	10 L	1	20 L	

To mix smaller quantities, use the following table and multiply as needed:

To Make 1 Litre Working Strength Developer Solution		
Start with Developer Concentrate	Add Water at 10 - 30°C (50 - 86°F) to Make 1 L	Stir
250 mL	750 mL	Stir for about 2 minutes until a completely homogeneous solution is obtained.

### Automixer Mixing

Remove the bottle caps (leaving seal intact) and place bottle in the automixer template. The automixer will add water to achieve the proper volume or specific gravity (1.071), depending on the type/model of automixer.

### INDUSTREX Single Part Developer Starter

The INDUSTREX Single Part Developer Starter is used with the INDUSTREX Single Part Developer Replenisher to prepare a developer working-strength startup solution for automatic processing. The use of starter is not necessary for manual or tank processing.

Add 31 mL of starter solution per 1 litre of the mixed INDUSTREX Single Part Developer Replenisher.

## INDUSTREX LO Fixer and Replenisher

To Make	Start with Water at 10 - 30°C (50 - 86°F)	Add Concentrate (Number of Bottles), Stirring Constantly	Fill to:	Stir
19 L	10 L	1	19 L	Stir continuously for about 2 minutes until a completely homogeneous solution is obtained.
20 L	10 L	1	20 L	

To mix smaller quantities, use the following table and multiply as needed:

To Make 1 Litre Working Strength Fixer Solution			
Starting With Package That Makes	Start with Fixer Concentrate	Add Water at 10 - 30°C (50 - 86°F) to Make 1 L	Stir
19 L	200 mL	800 mL	Stir for about 2 minutes until a completely homogeneous solution is obtained.
20 L	250 mL	750 mL	

## Automixer Mixing

Remove the bottle caps (leaving the seal intact) and place the bottles in the automixer template. The automixer will add water to achieve the proper volume or a specific gravity (1.066 for 19 L mix, 1.084 for 20 L mix), depending on the type/model of the automixer.

### Film Characteristics (Sensitometric)

Exposure Conditions—200/220 kV, ISO/EN Conditions, INDUSTREX Chemicals, INDUSTREX M43ic Processor

Cycle	DR50		M100		MX125		T200		AA400		HS800	
	Base + Fog	Contrast†	Base + Fog	Contrast†	Base + Fog	Contrast†	Base + Fog	Contrast†	Base + Fog	Contrast†	Base + Fog	Contrast†
8 min 79 °F (26 °C)*	0.19	5.40	0.19	5.40	0.20	5.15	0.19	4.70	0.20	4.70	0.22	4.40
5 min 86 °F (30 °C)	0.20	5.55	0.19	5.25	0.20	5.05	0.20	4.70	0.20	4.65	0.23	4.30

† Contrast calculated between net densities of 1.5 and 3.5.

## RECOMMENDED REPLENISHMENT RATES

The consistency of the radiographic quality is related to the accurate adjustment of the replenishment rate. Replenishment should maintain the chemical equilibrium, replacing the components used by the film.

Solution	Replenishment Volume	
	per 35 x 43 cm (14 x 17 inch) sheet	per m <sup>2</sup>
INDUSTREX Developer Replenisher or Single Part Developer Replenisher	100 mL (3.38 oz)	665 mL (22.48 oz)
INDUSTREX LO Fixer and Replenisher	180 mL (6.08 oz)*	1200 mL (40.57 oz)

\* For optimum archivability, a 10% increase in fixer replenishment rate may be desirable.

## WASHING AND DRYING

**Washing:** Follow the processor manufacturer's recommendation for wash flow rate, or adjust flow to achieve the equivalent of the wash tank capacity every five minutes, or twelve tank volumes per hour. Insufficient wash flow can adversely affect the life expectancy of processed radiographs. Wash flow rate should be increased if chemical spot tests or other analytical methods reveal a high level of retained chemicals in the processed film. For best results, the wash tank should be drained daily and left empty when not in use.

**Drying:** Follow the processor manufacturer's recommendation for dryer settings. In general, the dryer should be set to a temperature slightly above (3°C/5°F) the lowest temperature required to eliminate any signs of tackiness in films exiting the dryer.

# Manual Processing

To reach the desired density on a radiograph, many people use set exposure factors and then adjust development time—or “sight develop”—to compensate for under- or overexposed images.

Today, you can eliminate that guesswork and get more consistent results by using INDUSTREX Films with our exclusive tabular emulsion technology. The key is to use the correct exposure factors when you shoot the images. We provide convenient INDUSTREX Film Exposure Calculators to help you determine the correct factors for each situation.

By removing the processing variable, you will get better consistency and higher productivity in the darkroom. Our films provide stable contrast and a relatively stable speed over a wider range of developer temperatures—unlike older film technologies that have highly variable speed, relative to developer temperature and immersion time.

When using an Ir-192 source, you can use the INDUSTREX Film Exposure Calculator to determine the correct exposure (based upon density desired).

Then, follow these simple processing recommendations.

## Timer and Thermometer

The timer and the thermometer are essential. They must be accurate and in good condition.

## Film Handling

Do not bend the film. Handle the film only by the edges to avoid finger marks and abrasions when loading on hangers. Separate the hangers in the solutions so that the films will not touch each other or the tank wall.

## RECOMMENDED CHEMICALS

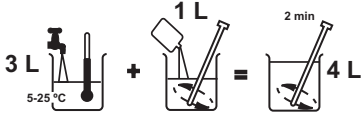
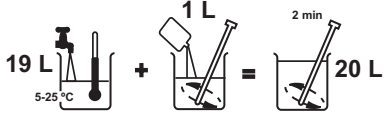
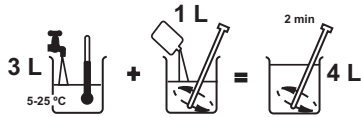
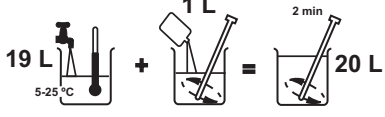
	Dilution Concentrate + H <sub>2</sub> O	Replenishment Rate	pH Working Strength	Specific Gravity Working Strength	To Make Working Strength Solution
<b>Developer</b>					
Use INDUSTREX Manual Developer and INDUSTREX Manual Developer Replenisher.	1 + 3	665mL/m <sup>2</sup> (e.g., 100 mL per 14 x 17 inch sheet)	10.55 +/- 0.10 (25° C, 77° F)	1.078 +/- 0.005 (20° C, 68° F)	
<b>Stop Bath</b>					
Use INDUSTREX Manual Stop Bath. This stop bath rapidly halts development, preventing most spotting and streaking and prolongs the life of the fixing bath. This odorless stop bath features an indicator that changes color (from orange-yellow to magenta-red) at pH 5.2 to alert the user of declining activity, so that the solution can be changed or additional concentrate added.	1 + 19	No replenishment required.  Add water to compensate for carryover and evaporation. Change out the solution when a color change occurs, or add more concentrate.	2.20 +/- 0.10 (25° C, 77° F)	— —	
<b>Fixer</b>					
Use INDUSTREX Manual Fixer and INDUSTREX Manual Fixer Replenisher.	1 + 3	1200mL/m <sup>2</sup> (e.g., 180mL per 14 x 17 inch sheet)  It may be necessary to discard some used solution before adding the proper volume of replenisher.	5.80 +/- 0.10 (25° C, 77° F)	1.095 +/- 0.005 (20° C, 68° F)	
<b>Final Rinse</b>					
Use INDUSTREX Manual Rinse Solution. This solution is a wetting agent that effectively reduces water spots and drying marks.	1 + 19	No replenishment required.  Add water to compensate for carryover and evaporation. Change out the solution when other solutions are changed.	— —	— —	

H242\_0038

### Film Characteristics (Sensitometric)

Exposure Conditions—200/220 kV, lead screens, ISO/EN Conditions, INDUSTREX Single Part Developer Replenisher

Cycle	DR50*		M100*		MX125		T200*		AA400*		HS800	
	Base + Fog	Contrast†	Base + Fog	Contrast†	Base + Fog	Contrast†	Base + Fog	Contrast†	Base + Fog	Contrast†	Base + Fog	Contrast†
5 min 68 °F (20 °C)	0.20	5.10	0.19	5.00	0.19	5.00	0.20	4.80	0.25	4.20	0.23	2.60
3 min 75 °F (24 °C)	0.20	5.00	0.19	5.30	0.19	5.10	0.20	4.80	0.20	4.30	—	—

† Contrast calculated between net densities of 1.5 and 3.5.



## SPECIFIC GRAVITY

Measurement of SpG of freshly prepared processing solutions can reveal mixing errors, and can be easily accomplished with a graduated cylinder and an appropriate hydrometer.

To measure specific gravity:

1. Fill a clean, dry 250 mL graduated cylinder to within 1 inch (2.5 cm) of the top with the solution you are measuring.
2. Adjust the solution to the proper temperature (25 °C, 77 °F). Note that proper solution temperature is very important.
3. Place the cylinder in a sink or tray to catch overflow.
4. Choose the correct hydrometer to match the approximate specific gravity of the solution.
5. Be sure that the hydrometer is clean and dry. Carefully lower the hydrometer into the solution in the cylinder. Let it bob up and down slightly. When it stops, read the number at the top of the meniscus.
6. After making the measurement, discard the sample.
7. Rinse the hydrometer and graduated cylinder thoroughly with water.

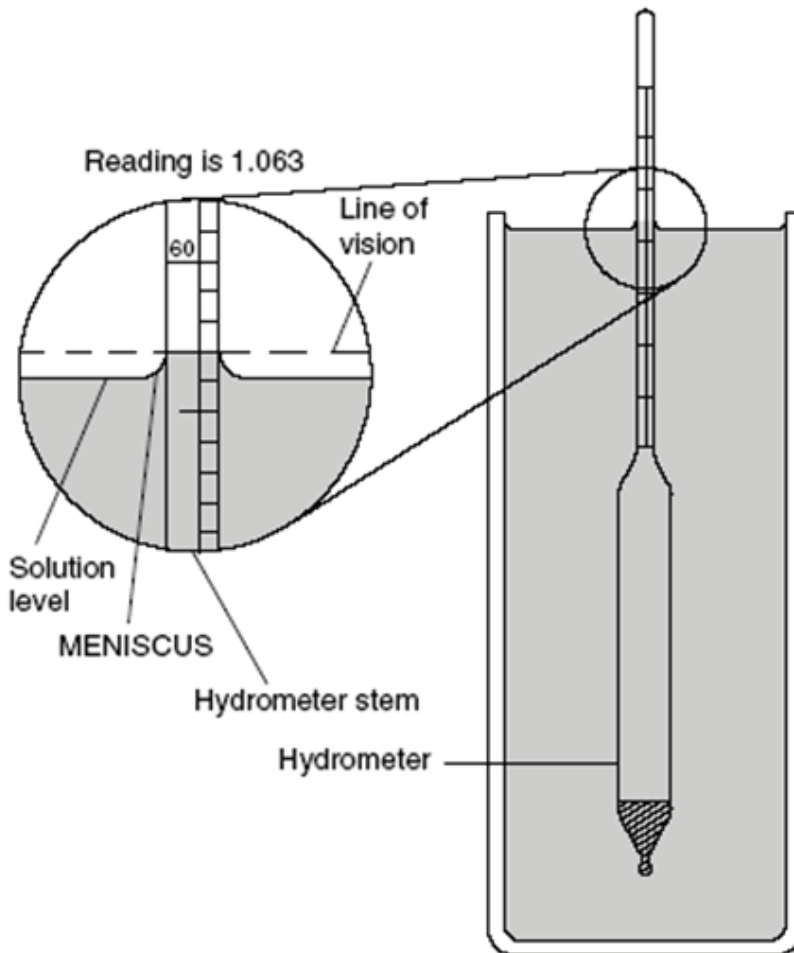

H242\_0036

## REPLENISHMENT RATES

Maintain the chemical activity and solution level in the tank by adding replenisher according to the instructions below:

Solution	Replenishment Volume	
	per 14 x 17 inch sheet	per m <sup>2</sup>
Developer	100 mL	665 mL
Fixer*	180 mL	1200 mL

\* For optimum archivability, a 10% increase in fixer replenishment rate may be desirable.

Stir solutions vigorously after each addition. Follow the manufacturer's instructions for the specific developer replenisher and fixer replenisher you are using.

Additionally:

- When removing films from a developer tank, DO NOT ALLOW THE EXCESS SOLUTION TO DRAIN BACK INTO THE TANK. Normally this will carry out the proper amount of solution to permit correct replenishment.
- Use floating covers on the developer tanks to reduce oxidation and evaporation; store developer replenisher in a closed container.
- Fill the developer and fixer tank to its original level each morning with developer or fixer replenisher solution (topping off).
- Discard solution after adding two tank volumes of replenisher to the tank, or at least once per month, and then refill with fresh solution.

## ENSURING PROCESS QUALITY

### Residual Thiosulfate Test

Use a test kit to ensure good keeping characteristics for radiographs. A test such as the CARESTREAM X-Omat Hypo Test Kit (CAT 196 5847) determines whether film has been adequately washed and provides an estimate of the archival life you can expect. The kit comes complete with testing solution and a visual estimator.

### Residual Silver Test Solution

An overworked fixing bath contains complex silver thiosulfate compounds that cannot be removed completely by washing. A residual silver test solution provides a quick and accurate method for determining when a fixing bath should be discarded. Prepare the test solution as follows:

Water	100 mL
Sodium Sulfide (Anhydrous)	2 grams

**To Use:** Store stock solution in a small stoppered bottle not more than 3 months. Dilute 1 part stock solution with 9 parts water. (Replace the working solution weekly.) Place a drop of the test solution on the margin of the processed film. Remove solution after 2 to 3 minutes. Any yellowing of the test area indicates the presence of silver. Refix the film in fresh fixer and rewash. The yellow stain is permanent.

### Fixer Test Solution

A fixer test Solution is used to check the silver content of the fixer bath. Prepare the test solution as follows:

Water at 27 °C (80 °F)	750 mL
Potassium Iodide	190 grams
Water to make	1 litre

To 5 drops of the test solution, add 5 drops of the fixing bath and 5 drops of water. Discard the fixer if a yellow-white precipitate forms instantly. (Any slight milkiness can be disregarded.)

You can also use silver estimating test papers to measure the silver content in your fixer. One supplier is USI International, Inc. ([www.silverprofit.com](http://www.silverprofit.com)).

# DEVELOPER TIMES AND TEMPERATURES

## Manual Processing Cycle

	Developer	Stop Bath	Fixer	Wash	Rinse Solution
Time/Temperature	5 minutes - 20°C (68°F) 4 minutes - 22°C (72°F)* 3 minutes - 24°C (75°F) 2 minutes - 26°C (79°F)	30 seconds	3 to 6 minutes or twice the time to clear film	10 to 30 minutes in running water (8 volume changes per hour)	30 seconds
Notes	<p><b>Important: Agitate 15 seconds at immersion, then intermittent - 5 seconds every 30 seconds.</b></p> <p>Use floating covers on the developer tank to reduce oxidation and evaporation; store developer replenisher in a closed airtight container.</p> <p>Fill the developer tank to its original level each day (topping off) with developer replenisher solution.</p>	<p><b>Important: PULL AND PLUNGE FILM DIRECTLY FROM DEVELOPER INTO STOP BATH. DO NOT ALLOW excess developer to drain back into developer tank. Continuous moderate agitation.</b></p> <p>Fill the Stop Bath to its original level each day (topping off) with water.</p>	<p>Fill the fixer tank to its original level each day (topping off) with fixer replenisher solution.</p>	<p>Fill the final rinse to its original level each day (topping off) with water.</p>	
	<p>Stir solutions after each addition.</p> <p>Discard solutions after adding two tank volumes of replenisher to the tank, or at least once per month, and then refill with fresh solution.</p>				

\* Recommended

H242\_0039

## INDUSTREX Film Exposure Calculator

The INDUSTREX Film Exposure Calculator eliminates guesswork in determining the proper exposure and processing when using an Ir-192 source. It provides the proper exposure for a given material thickness, distance, source strength, and development. Today, many shots are lost due to sight adjustment of density during the development cycle, so we removed the development variable to make your results more consistent. But again, getting the proper exposure is critical—so use the calculator for the correct factor for your situation. Contact your CARESTREAM sales representative for availability. The INDUSTREX Film Exposure Calculator was standardized with a development time of 4 minutes at 72 °F.

## Your Step-by-Step Guide to Processing INDUSTREX Films

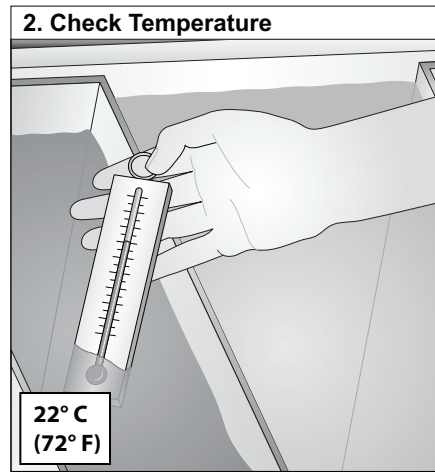
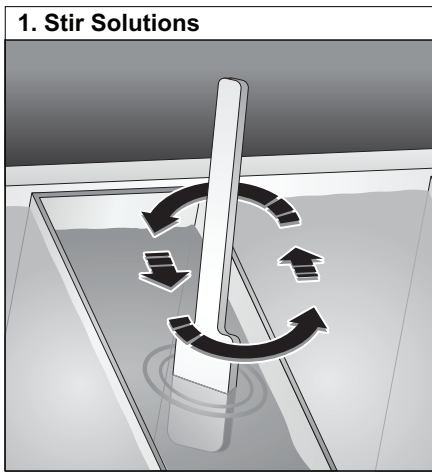

1. Stir the developer and fixer to equalize their temperatures. Use separate paddles for each to avoid contamination.
2. Check the temperature of the solutions with an accurate thermometer, rinsing it off after checking each one. Adjust the temperature as needed.

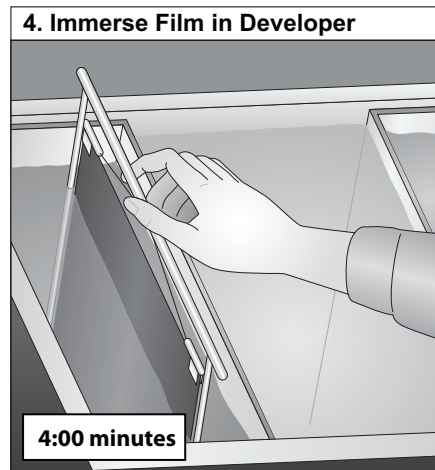
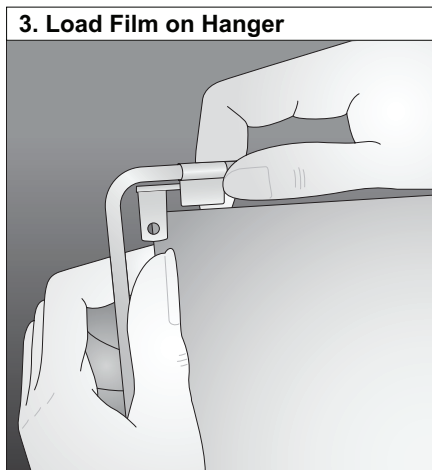

3. Attach the film carefully to a proper-sized hanger. Attach the lower corners first. Avoid finger marks, scratches or bending.
4. Set a timer. **5 minutes** at 68°F (20°C) is recommended; 4 minutes at 72°F (22°C) is recommended if using the INDUSTREX Film Exposure Calculator.

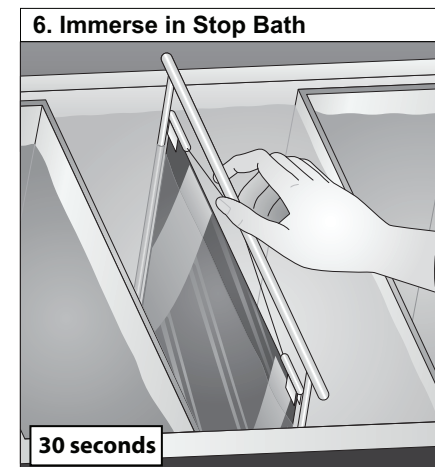
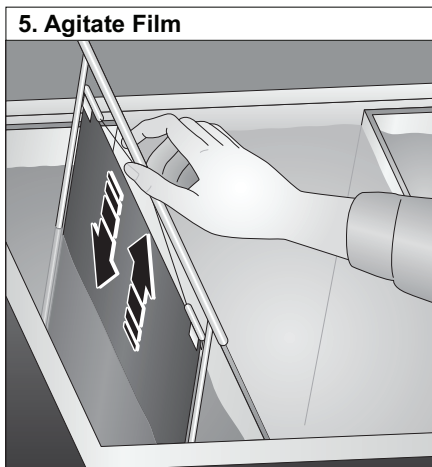

5. Immediately after immersion in the developer, tap the hanger to dislodge air bubbles. **Agitate for 5 seconds every 30 seconds.**
6. Place the film in the stop bath for **30 seconds**. Then agitate moderately, lift from the stop bath, and drain well.

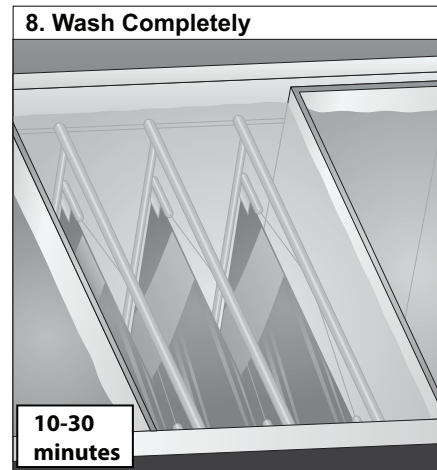
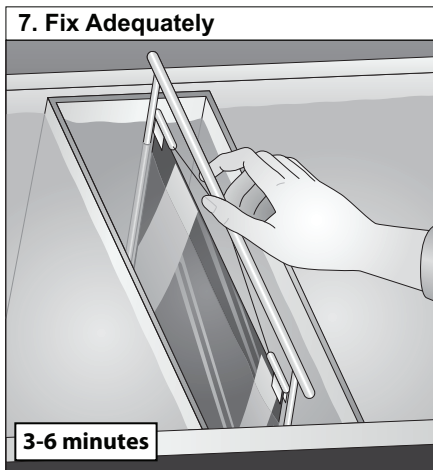

7. Immerse the film in the fixer for **3 to 6 minutes**, agitating for **5 seconds every 30 seconds**. Film should remain in fixer for twice the time it takes to “clear” it (when the milky look disappears). **Never fix film for less than 3 minutes.**
8. Place the film hangers in a tank of running water for **10 to 30 minutes**. Keep ample space between the hangers (water must flow over the tops).

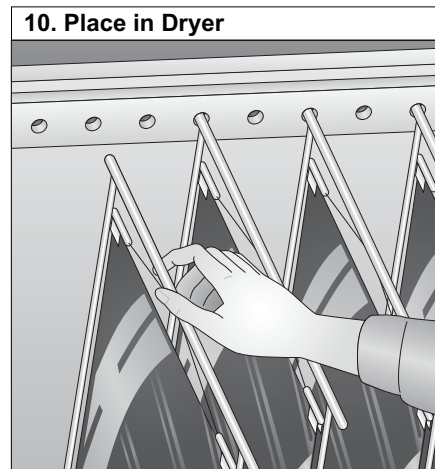
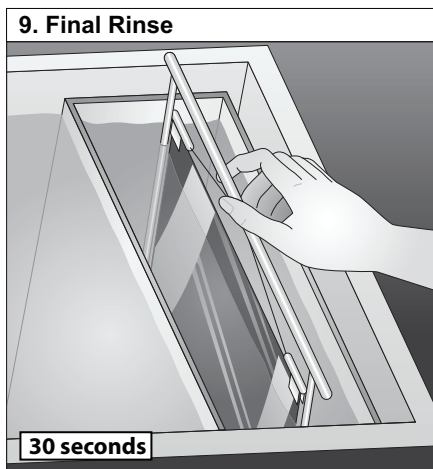

9. If facilities permit, use a final rinse with a rinsing (wetting) agent to speed drying and prevent water marks. Immerse film for about **30 seconds**, and then drain for several seconds.
10. Dry the film at room temperature in a dust-free area or suitable drying cabinet. The temperature must not exceed 120°F (49°C). When the film is dry, remove from hangers and insert into envelopes.

# Characteristic Curves

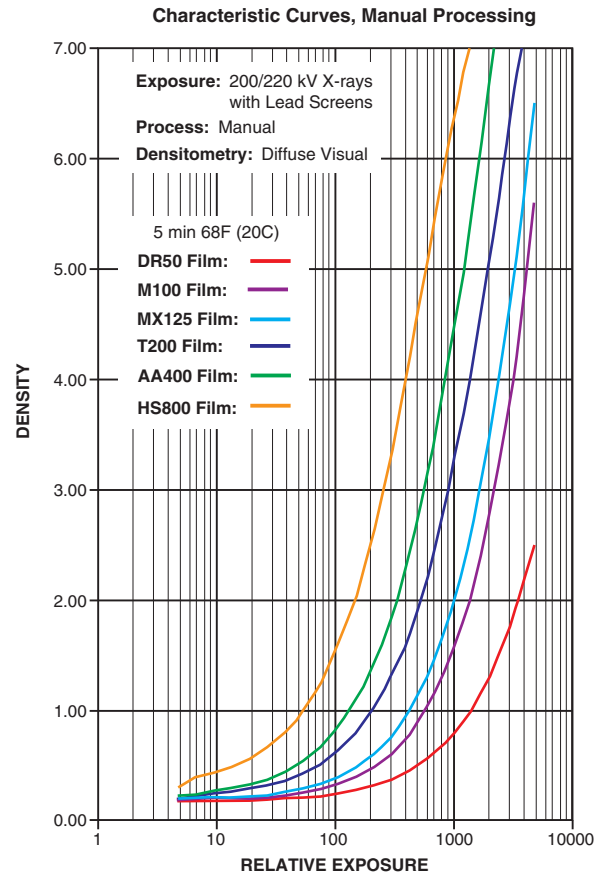
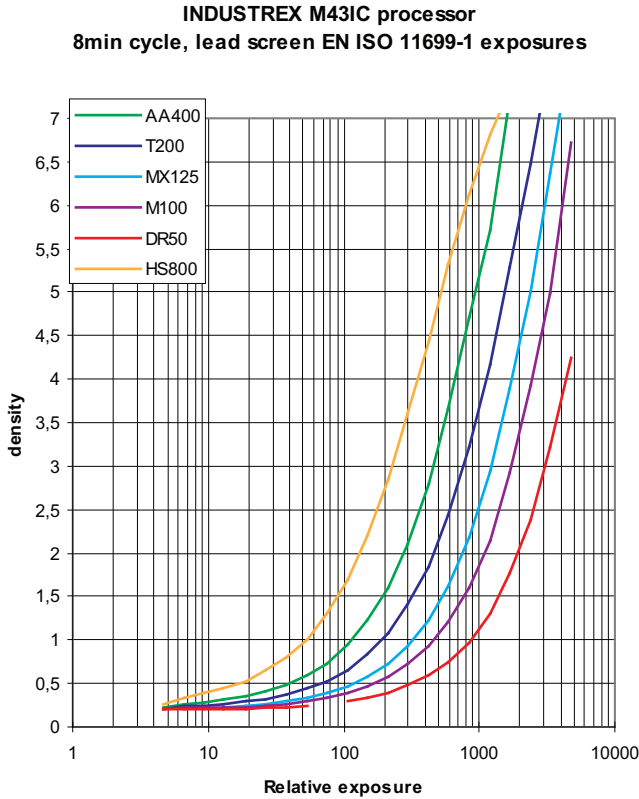

H242\_0037

## Additional Information on the INDUSTREX High-Speed HS800 Film

CARESTREAM INDUSTREX HS800 Film is the fastest and most versatile film for non-destructive testing. Now you can use one film for any exposure method—direct, lead screen, fluorescent screen, or fluorometallic screen. Designed for any high-density application where speed is an advantage, the HS800 Film is suitable for structural components such as bridges, concrete, or off-shore pipelines.

When used with fluorescent or fluorometallic screens, the HS800 Film displays high contrast throughout an extended range of optical densities, thus providing high sensitivity to flaw detection and wide exposure latitude.

HS800 Film incorporates patented tabular emulsion technology, which is just as effective in short automatic and manual processing cycles. Processed HS800 Film was designed to have cold image tone on the view box and high gloss, resulting in better perceived radiographs.

### Intensifying Screens

Modern industrial x-ray films incorporate emulsions mostly sensitive in the blue region of the electromagnetic spectrum. Calcium tungstate ( $\text{CaWO}_4$ ) was chosen as the luminescent material in intensifying screens because it emits light in the blue range with an emission maximum at about 420nm. More recently, phosphors such as oxysulfides of the rare earth elements have been used to produce ultra fast screens. Rare earth phosphors also emit light in the blue range to which the emulsion is mostly sensitive.

### Fluorescent Screens

Fluorescent screens can sometimes be used with advantage for industrial radiography. The normal calcium tungstate type screens will not reduce scatter, and the image quality of radiographs where the exposure has been made using these screens is not as good as that obtainable with lead screen exposures. However, calcium tungstate screens permit a considerable reduction in exposure, being most responsive to X-rays and intensifying by a factor of approximately 100 times.  $\text{CaWO}_4$  fluorescent screens are much less responsive to gamma rays (approximately 20-40 times), and the inherent low contrast of gamma radiographs plus the unsharpness caused by these screens will result in poor sensitivity and fault detection.

## **LANEX Fast Screens**

LANEX Fast Screens have a thin clear overcoat to resist surface abrasion and have a backing layer to eliminate curl. They incorporate as phosphor terbium-activated gadolinium oxysulfide,  $Gd_2O_2S:Tb$ , coated in a transparent binder. These screens, incorporating a rare-earth phosphor from the lanthanide series, have significantly much higher X-ray absorption and X-ray energy conversion than  $CaWO_4$  screens. Accordingly, LANEX Fast Screens permit a greater reduction in exposure than  $CaWO_4$  screens. LANEX Fast Screens yield excellent images when used with HS800 Film.

LANEX Fast Screens will be provided in asymmetrical pairs. The phosphor coverage of the non-tube (back) screen is more than twice that of the tube-side (front) screen. This allows for optimized light output from each of the screens during exposure.

## **Fluorometallic Screens**

Fluorometallic screens combine the advantages of both fluorescent and lead screens. They consist of a  $CaWO_4$  layer combined with a lead layer and will permit useful reductions in exposure—depending upon energy and exposure duration. Image definition is far better than with ordinary fluorescent screens, and the higher contrast produced by the light image emitted helps improve sensitivity of flaw detection.

## **Screen Care**

The temperature encountered in most industrial radiography laboratories does not significantly affect screen emission. However, it is noteworthy that screen emission increases as screen temperature is lowered.

Intensifying screens must be kept away from chemicals and other sources of contamination. Every effort should be made to avoid soiling intensifying screens. Should they become dirty, they must be carefully cleaned according to the manufacturer's recommendations.

Under normal use conditions, intensifying screens will deteriorate. The deterioration may occur from abrasion of the protective overcoat or inadvertent physical damage to the surface. Certain chemical agents—such as non-approved screen cleaners, hand lotions, topical medications, foodstuff, etc.—may also damage the screens. Some screen deterioration may result in artifacts on processed radiographs. As a general rule, intensifying screens in cassettes should be replaced at least every 5 years.

When screens are replaced for normal wear and tear, the cassette should also be considered for replacement, installing new screens in well worn cassettes may not improve image quality. All cassettes and screens should be inspected systematically for screen-film contact, lighttight integrity (including hinges) and general condition. To inspect screens, make a uniform exposure on a film sufficient to produce a density of 1.9 to 2.5. Examine the processed film for screen-related artifacts.

Experience indicates that best results are obtained by cleaning intensifying screens with an intensifying screen cleaner and antistatic solution. Some screen-cleaning agents may leave residues which would seriously affect the emission of these screens and may affect the photographic response of the film. The use of any cleaning agents other than those specifically suggested for cleaning intensifying screens is not recommended.

## **Antistatic Treatment of Intensifying Screens**

Intensifying screens and films are designed to minimize the sources of static marks on the processed radiograph. If static should occur, CARESTREAM Screen Cleaner should be used. Apply the solution to the screens with a clean, lint free pad. Do not wipe screens dry. Allow screens to air-dry completely before returning them to service.

## **Exposures with Fluorescent and Fluorometallic Screens**

The reciprocity law is accurate for direct x-ray and lead screen exposures.

When determining exposure conditions for radiography without screens or with lead screens, relationships such as mA/time and the inverse square law for time/distance calculations are such that a known change of mA or distance will result in a precise change of time.

However, for exposures to the light emitted from fluorescent and fluorometallic screens, the reciprocity law fails to apply. Because of this, it is not possible to give an intensification factor that applies to all exposure conditions.

## **Film Characteristics: Fluorescent or Fluorometallic Screens**

EXPOSURE CONDITIONS: 80 kV, fluorescent or fluorometallic screens, INDUSTREX Single Part Developer Replenisher and INDUSTREX LO Fixer and Replenisher, M43ic processor, 8 min 79°F (26°C) cycle.

### Film Characteristics (Sensitometric)

Screen	Base + Fog	Relative Exposure	Contrast
Kyokko SMP 308 screens	0.22	1.8	4.1
Rennex screens	0.23	1*	4.1
LANEX Fast Screens	0.23	0.25	4.8

\* HS800 Film used in combination with Rennex screens is assigned a relative exposure of 1.

### Spectral Sensitivity for the HS800 Film

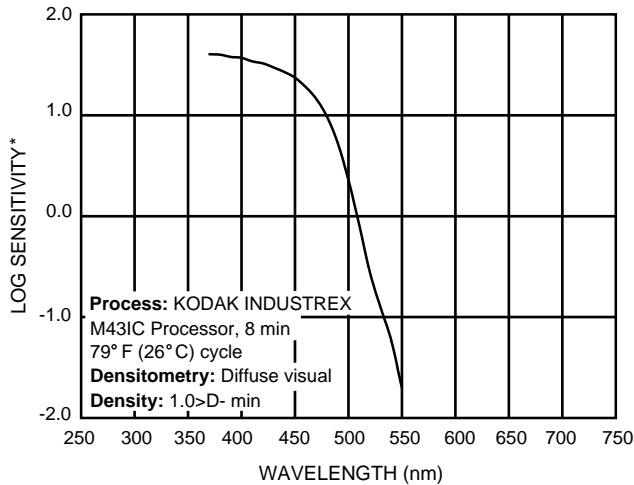

\*Sensitivity = reciprocal of exposure (erg/cm<sup>2</sup>) required to produce specified density

T12637C

## Life Expectancy of Processed Industrial Radiographs

The life expectancy of processed industrial radiographs is highly dependent on their processing and storage conditions. CARESTREAM cannot control customers' processing and storage conditions and therefore does not guarantee any particular life expectancy. The CARESTREAM "Limitation of Liability" is printed on every product label, and covers defective manufacturing and packaging.

While CARESTREAM cannot promise a specific life expectancy for radiographs made using its INDUSTREX Film Products, we can provide assistance to customers who wish to assess the long term keeping capability of their radiographs. In CARESTREAM testing of INDUSTREX Film Products, films were processed in an INDUSTREX Film Processor Model 431C, using INDUSTREX Single Part Developer Replenisher and INDUSTREX LO Fixer and Replenisher. The process cycle was the standard 8-minute cycle with a developer immersion time of 100 seconds at a temperature of 26 °C (79 °F), in accordance with the CARESTREAM published processing recommendation. Under these conditions, all films (INDUSTREX HS800, AA400, T200, MX125, M100, and DR50) showed less than 0.5 ug/cm<sup>2</sup> of retained Thiosulfate, per ISO Standard 18917. Each sample was analyzed and results were calculated using a carefully prepared calibration line. These data translate to a life expectancy of 500 years (LE500), per ISO Standard 18901, when stored properly. The film storage environment should be limited to the range of 4.4 °C (40 °F) to 24 °C (75 °F) and 30 % to 60 % RH, per ASTM Standard E 1254.

CARESTREAM encourages customers to assess the life expectancy of radiographs made using their own INDUSTREX Film Products, using the above referenced standards. We will be happy to assist if you should have any questions.

### References:

1. ISO 18917—Determination of residual thiosulfate and other related chemicals in processed protographic materials—Methods using iodine-amylose, methylene blue, and silver sulfide.
2. ISO 18901—Imaging Materials—Processed silver-gelatin type black-and-white films—Specifications for stability
3. ASTM E 1254—"Standard Guide for Storage of Radiographs and Unexposed Industrial Radiographic Films," ASTM International.



NOTICE: While the sensitometric data in this publication are typical of production coatings, they do not represent standards which must be met by CARESTREAM. Varying storage, exposure, and processing conditions will affect results. The company reserves the right to change and improve product characteristics at any time.

INDUSTREX, LEAD PACK, READY-PACK, and PHOTO-FLO are trademarks of Carestream Health, Inc.

Created in the USA. • TI-6K7080.fm

© Carestream Health, Inc., 2014.

Carestream Health, Inc.  
150 Verona Street  
Rochester, NY 14608  
United States

---